

DRAW LATCH

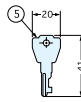

P-1040/SS

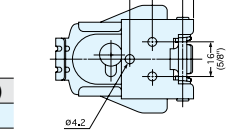
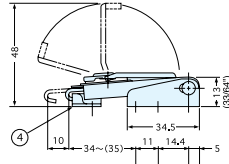
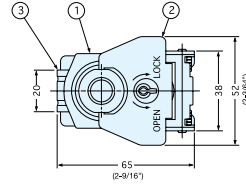

- Lift handle and turn 180° to open and close latch.
- Stainless steel draw latch with key.
- No key changes are available.

Item No.	Weight (g)	Box (pcs)	Carton (pcs)
P-1040/SS	105	60	240

No.	Part Name	Material	Finish
①	Body	304 Stainless Steel	Polished
②	Lever	304 Stainless Steel	
③	Hook	430 Stainless Steel	Polished
④	Counterplate	304 Stainless Steel	
⑤	Key	Steel	Nickel

DRAW LATCH



P-102H/SS

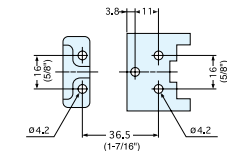
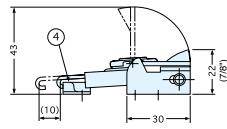
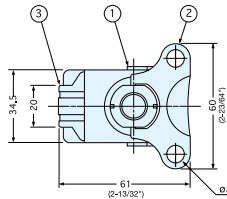

- Lift handle and turn 180° to open and close latch.

Item No.	Weight (g)	Box (pcs)	Carton (pcs)
P-102H/SS	85	60	600

No.	Part Name	Material	Finish
①	Body	304 Stainless Steel	Polished
②	Lever	304 Stainless Steel	
③	Hook	430 Stainless Steel	Polished
④	Counterplate	304 Stainless Steel	

MINI DRAW LATCH



PN-51

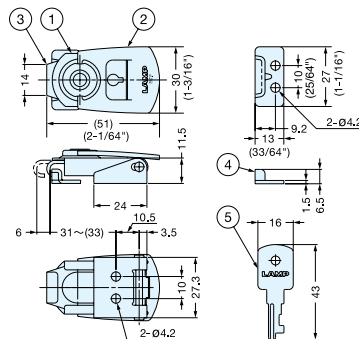

- Lift handle and turn 180° to open and close latch.
- Small stainless steel draw latch with key.
- No key changes are available.

Item No.	Load Capacity (kg)	Weight (g)	Box (pcs)	Carton (pcs)
PN-51	80 (176 lbs)	50	40	400

No.	Part Name	Material	Finish
①, ②	Body, Lever	304 Stainless Steel	Plain
③	Hook		
④	Counterplate	Steel	Nickel
⑤	Key		