



# ASSEMBLY HARDWARE



## ASSEMBLY HARDWARE

Installation and assembly hardware for professional efficiency

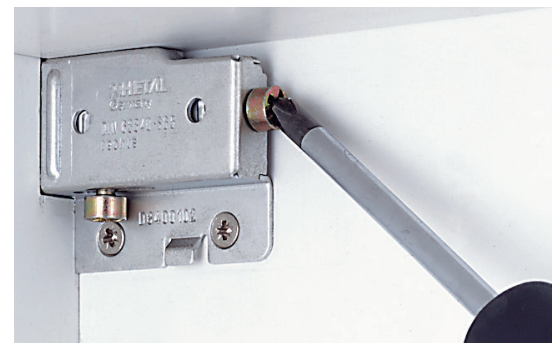

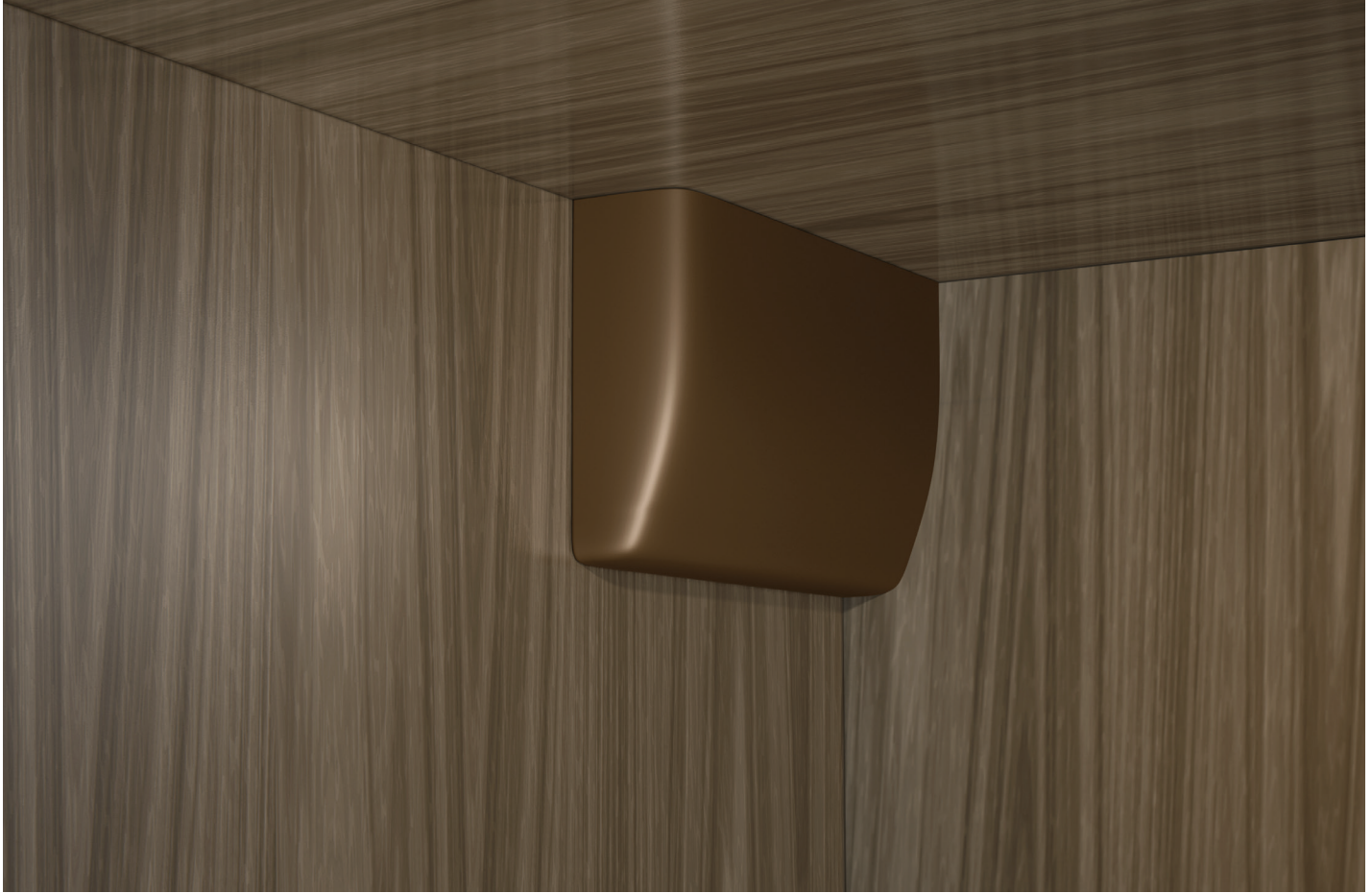





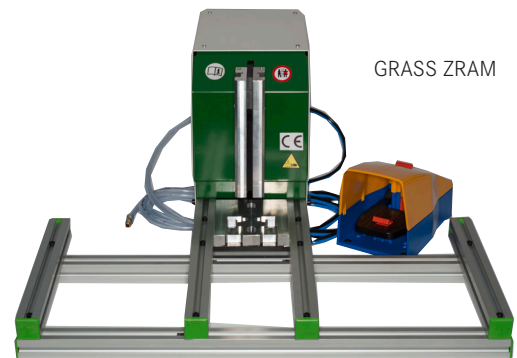
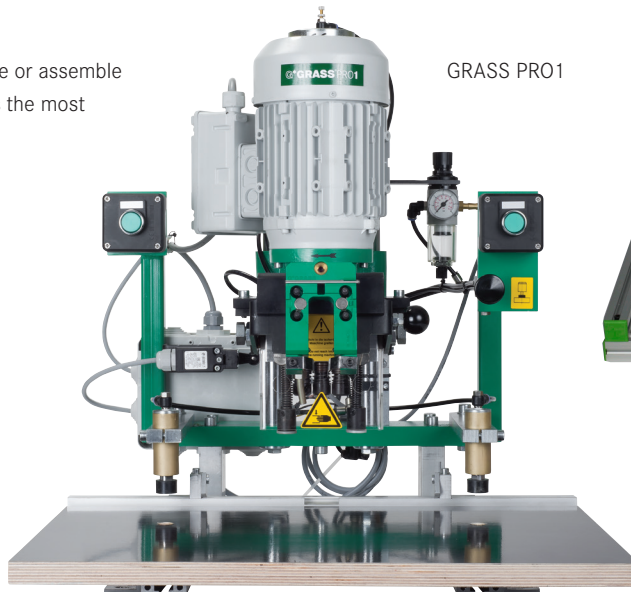



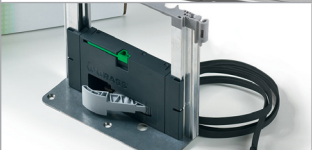

Installation and assembly aids for all product families -  
designed to suit our customer's needs.

Whether you want to insert a hinge or assemble  
a drawer - Grass machinery offers the most  
economical solution.

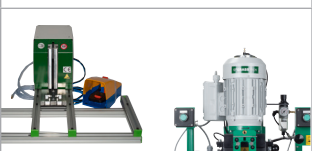

## Table of Content

	Description		Page
	<p><b>Cabinet Suspension System</b></p> <ul style="list-style-type: none"> <li>• All steel suspension system</li> <li>• Carrying capacity - 286 lbs</li> </ul>		4
	<p><b>UniSoft</b></p> <ul style="list-style-type: none"> <li>• For all face frame overlay cabinets</li> <li>• For full overlay frameless cabinets</li> </ul>		6
	<p><b>Tipmatic</b></p> <ul style="list-style-type: none"> <li>• For use with free swinging hinges</li> <li>• For handle free doors</li> </ul>		7
	<p><b>Soft-close Damper</b></p> <ul style="list-style-type: none"> <li>• For Zargen and Integra Slides</li> <li>• Easy to mount</li> </ul>		8
	<p><b>Sensomatic</b></p> <ul style="list-style-type: none"> <li>• For Vionaro, Dynapro and Nova Pro</li> <li>• Automatic drawer opening</li> </ul>		8
	<p><b>Accessories</b></p> <ul style="list-style-type: none"> <li>• Door protectors</li> <li>• Alignment aids</li> </ul>		9
	<p><b>Shelf Supports and Bumpers</b></p> <ul style="list-style-type: none"> <li>• Supports made from steel and plastic</li> <li>• Various styles of plastic bumpers</li> </ul>		10
	<p><b>Screws and Dowels</b></p> <ul style="list-style-type: none"> <li>• Euro and Wood screws</li> <li>• Dowels for hinges and slides</li> </ul>		11
	<p><b>Machinery</b></p> <ul style="list-style-type: none"> <li>• GRASS PRO 1</li> <li>• GRASS ZRAM</li> </ul>		12
	<p><b>GRASS Product Selector (GPS)</b></p> <ul style="list-style-type: none"> <li>• Windows 10 compatible</li> <li>• Available for Kinvaro, Tiomos, and Dynapro</li> </ul>		15

# Cabinet Suspension System

## Suspension rail, brackets, and covers



- All steel suspension system
- Carrying capacity - 286 lbs
- Plastic covers available
- Precision height, depth, and side adjustments for brackets
- Self-centering suspension rail - 16" center to center

### Suspension Rail, Covers

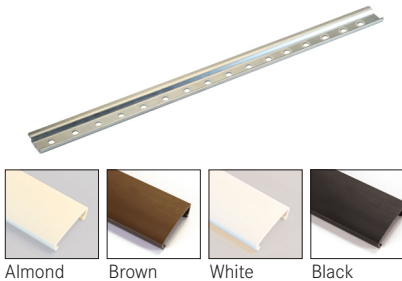

Description	Length	Material/Color	Item No.	PU
Rail	8'	Steel	499.831.00.1719	25
Cover	8'	Plastic, almond	499.831.00.0153	50
		Plastic, brown	499.831.00.0158	50
		Plastic, white	499.831.00.0174	50
		Plastic, black	499.831.00.0162	50

### Suspension Bracket with Cover Cap

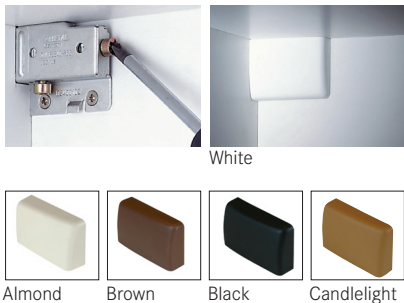

Description	Material/Color	Item No. Left	Item No. Right	PU
Bracket	Steel	<b>F155145068</b> 233	<b>F155145067</b> 233	200
Cover	Plastic, white	<b>F155145038</b> 133	<b>F155145039</b> 133	
	Plastic, almond	<b>F155145062</b> 133	<b>F155145066</b> 133	
	Plastic, brown	<b>F155145060</b> 133	<b>F155145064</b> 133	
	Plastic, black	<b>F155145061</b> 133	<b>F155145065</b> 133	
	Plastic, candlelight	<b>F155145059</b> 133	<b>F155145063</b> 133	

### Assembly Screw



Description	Material/Color	Item No.	PU
6.3 x 16mm panhead screw	Steel	499.390.62.6115	5000

PU - Packaging unit

## Suspension Rail Installation

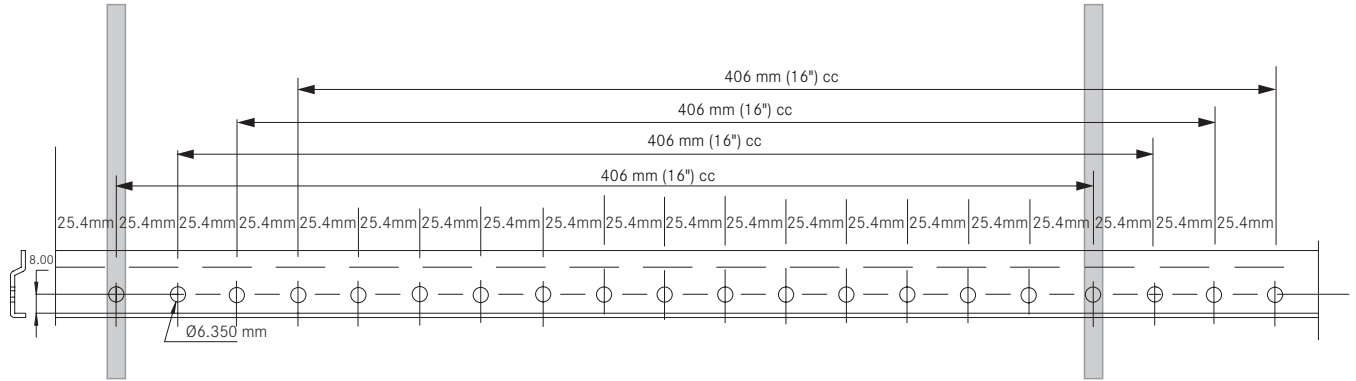

## Suspension System Installation

Required space in the cabinet

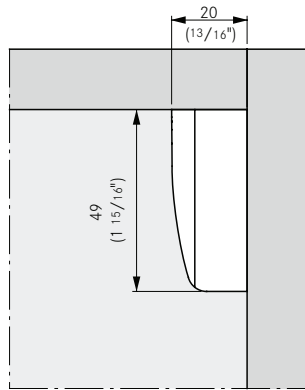

Required space on the side wall

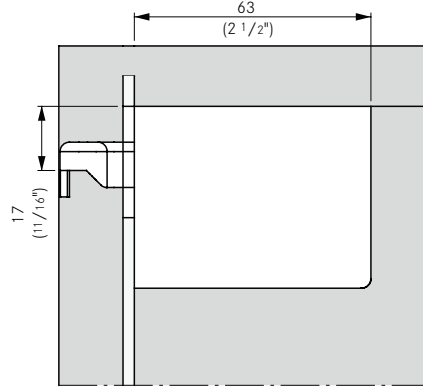

Back panel cut-out

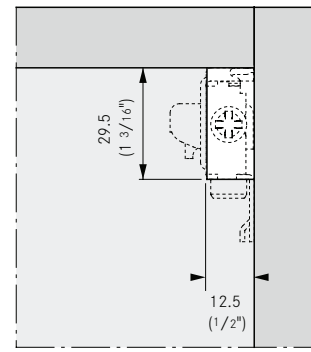

Fixture for closet

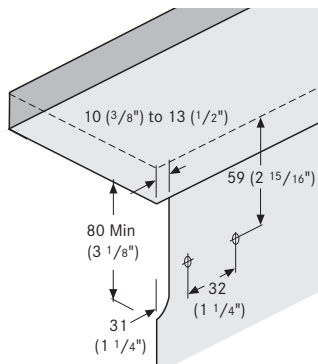

Fixture for cabinet

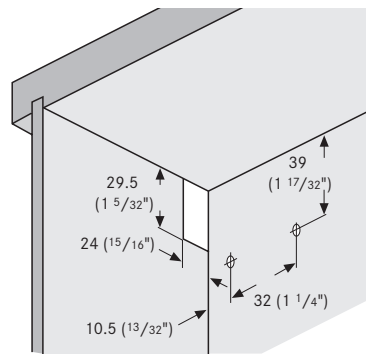

Adjustment



Suspension rail adjustment range:

- Downwards 10mm (13/32")
- Upwards 8mm (5/16")
- To the rear 7mm (1/4")
- To the front 7mm (1/4")
- To the left 9mm (11/32")
- To the right 9mm (11/32")

Suspension rail adjustment range:

- Downwards 10mm (13/32")
- Upwards 8mm (5/16")
- To the rear 7mm (1/4")
- To the front 7mm (1/4")
- To the left 9mm (11/32")
- To the right 9mm (11/32")

## Soft-close for doors



- Works for face frame cabinets on all door overlays
- Works for frameless cabinets on full overlay doors
- Brushed nickel look blends in well with hinge finish
- Non-handed with a low profile design
- Manually adjustable to desired closing speed
- Mounts independently from the hinge in the upper corner of the cabinet
- Instantly allows the cabinet door to close quietly and smoothly
- Scratch protector and front bumper with cushion for a quiet close

### UniSoft Adapter



Description	Material	Item No.	PU
UniSoft, Polybag	Plastic, chrome	18971-37	1
UniSoft, Polybag Bulk	Plastic, chrome	18971-40	25
UniSoft, Bulk	Plastic, chrome	18971-14	250

Includes #6 x 3/4 Pan head screw

### Installation

### Mounting Position

### Adjustment

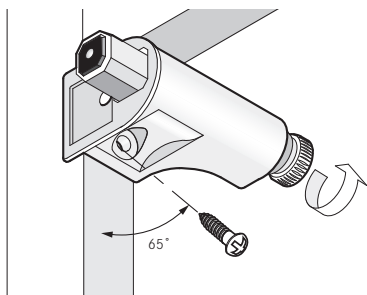

Use a 65° angle for best base results. Pilot drill 2.3mm [Ø3/32"] and 1/4" deep for a #6 x 3/4" Pan head screw recommended. Mount in upper corner on hinge side.

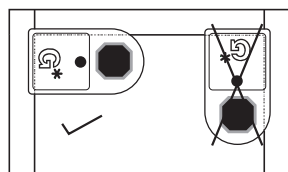

**IMPORTANT** The installation of our cabinetry hardware must comply with the Grass instructions that are stated on this catalog page.

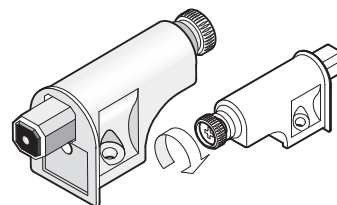

Turn adjustment screw to move damper in and out. Adjust in for heavier doors or out for light doors. Use Phillips or Pozidrive screwdriver or adjust manually.

### Dimensions

### UniSoft Per Door

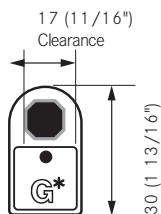
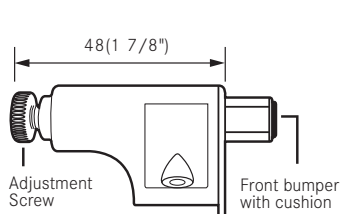

Use one UniSoft for most applications. For heavier doors use two or more. Trial mount recommended.

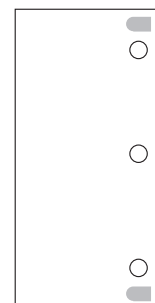
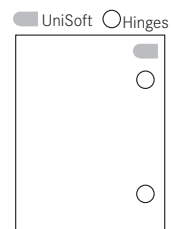

PU - Packaging unit

## For handle-free wooden doors



- Gently tapping the front causes the doors to open to a convenient angle
- Use with Tiomos Tipmatic Plus or with Nexis and Tiomos free-swinging hinges
- Large magnet catch range – holds door closed securely
- Gap adjustment from 2.5 to 5.5mm with integrated, self-locking and tool-free depth adjustment feature
- Mount on the front side of the cabinet or with an adapter plate

### Tipmatic Pin



- Incl. Tipmatic mechanism:
  - Stick on strike plate
  - Screw on strike plate
- Hole drilled from the front
- Plastic RAL 7036, platinum grey

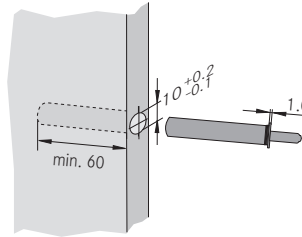

### For Drilling

Item No.	PU
68873-06	25

### Adapter Plate for Line Boring



- Suitable for line boring 28 and 37mm
- Attach with Euro screws (6.3 x 13.5)
- Plastic RAL 7035, light grey

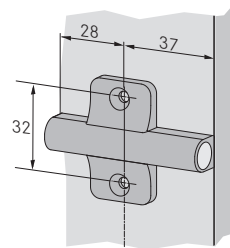

### For Euro Screws

Item No.	PU
63310-40	25

### Face Frame or Standard Adapter Plate



- Quick upgrade installation
- Attach with wood screws (3.5 x 13)
- Plastic RAL 7035, light grey

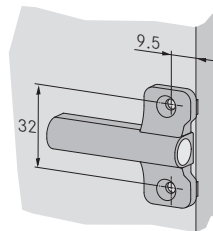

### For Wood Screws

Item No.	PU
63311-40	25

### Linear Adapter Plate



- Design solution – also suitable for inset door applications
- Attach with wood screws (3.5 x 13)
- Plastic RAL 7035, light grey

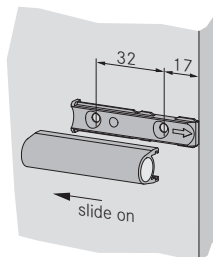

### For Wood Screws

Item No.	PU
63309-40	25

PU - Packaging unit

# Soft-close Damper Set

For Zargen and Integra

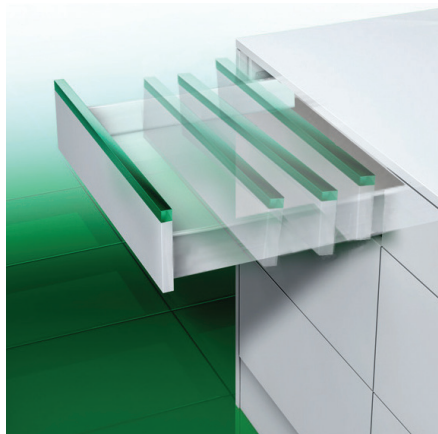

- Add-on damper creates a smooth soft-close action
- Oil closing mechanism for improved performance
- Three options for various load capacities
- Actuator design allows for flush mounting



For Zargen Drawer System  
(Damper set does not include drawer box.)



For Integra Drawer System  
(Damper set does not include drawer box.)

## Soft-close Damper

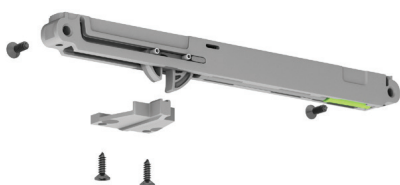

Description	Load Capacity	Item No.	PU
15 Kg Damper set	33 lbs	02394-11	140
30 Kg Damper set	66 lbs	02395-11	140
70 Kg Damper set	154 lbs	02396-11	140

Note: Bulk Damper sets do not include screws.

# Sensomatic

For Dynapro, Vionaro, and Nova Pro

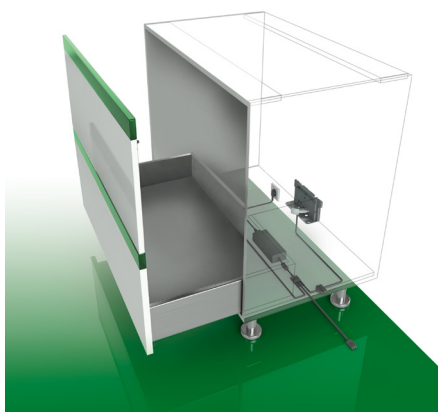

- Sensomatic works with any Dynapro, Vionaro, or Nova Pro drawer design
- Activated by a light touch anywhere on the drawer front
- One drive unit for cabinet widths up to 47" (1200 mm)
- Full extension for maximum access to drawer contents
- Soft-closing action pulls the drawer closed

## Sensomatic Kit



Set includes:

- Opening unit: 1
- Base frame: 1
- Powersupply unit: 1
- Power cord: 1
- Front bumpers  
(F121100296223): 4

Description	Item No.	PU
Sensomatic Kit	<b>F121100697201</b>	1

PU - Packaging unit



## Cover Caps

Hole covers for 35mm cup drillings



Description	Item No.	PU
35mm cover cap, white	22227-42	100
35mm cover cap, almond	22228-42	100
35mm cover cap, brown	22229-42	100

## Drawer Front Adjuster

For precise drawer front alignment

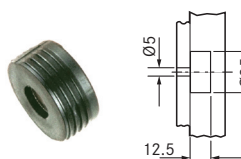

Description	Item No.	PU
Plastic, black	351.002.00.2662	200

Includes 4 x 22mm screw

## Door/Drawer Protectors

### Door Protector for Pull-outs

Protects door when inset trays are pulled out. Attached to the bottom of the pull-out, designed for use with the 6610.



Description	Item No.	PU
6197 Protector, left	88094-09	100
6197 Protector, right	88095-09	100

### Drawer/Door Protector

Attaches to side of wooden pull-out. Designed for inset pull-out trays for frame or frameless cabinetry.

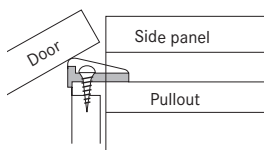

Description	Item No.	PU
Drawer/door protector	13096-43	500

## Inset Bracket Set

- For face frame inset applications with Dynapro
- Works with all inset applications
- Bracket mounts behind the face frame, minimum 12.7mm (1/2") frame offset required
- Slide attaches easily with one screw
- Includes guide markings for proper setback
- Polybagged with brackets, screws, instructions

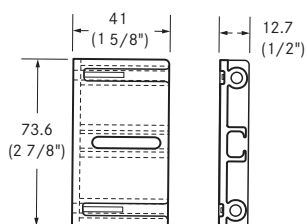
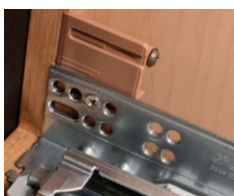

Description	Item No.	PU
Inset bracket set	13901-37	1
Inset bracket set	13901-08	50

Polybag includes:

- 2 - Universal inset bracket ABS brown
- 2 - 8 x 32 tapped insert for inset bracket
- 4 - #7 x 2" mounting screws
- 2 - #8 - 32 x 1/2" machine screw FHP

PU - Packaging unit

# Assembly Hardware

## Shelf Supports



Description	Item No.	PU
Plastic, clear, with steel pin	499.582.50.0050	5000
Metal spoon, nickel plated	499.582.50.2050	2000
Shelf support 7006/9.5, nickel	517.206.64.1015	2500
Shelf support 7035, nickel	517.206.61.0015	2500
H-802 plastic, square, clear	00036-43	500

## Bumper Pads

### AIRSOFT Bumper Pads, Plastic, Round



Description	Item No.	PU
AirSoft Bumper pad, 2.5mm, clear	63480-99	480
AirSoft Bumper pad, 2.5mm, clear	63482-30	5000
AirSoft Bumper pad, 5mm, clear	63481-43	500
AirSoft Bumper pad, 5mm, clear	63483-30	5000

### Self-adhesive Bumper Pads



Description	Item No.	PU
Self-adhesive bumper pad, clear, 7mm	630.000.03.0750	1088
Self-adhesive bumper pad, clear, 10mm	630.000.03.1050	1050
Self-adhesive bumper pad, clear, 12mm	630.000.02.1250	5000

## Bumper Pads



Description	Item No.	PU
Bumper pad, round, clear, 3mm	31002-43	500
Bumper pad, round, clear, 1.5mm	31004-43	500

## Bumper Pads

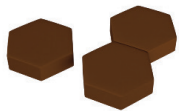

Description	Item No.	PU
Bumper pad, hexagonal, butterscotch, 3mm	00464-43	500

## Door Stop



Description	Item No.	PU
H-950 door stop, clear	00068-43	500

PU - Packaging unit

## Screws and Dowels

### Euro Screw, Nickel-plated

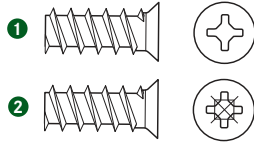

Description	Item No.	PU
1 13mm Euro Screw (1/2")	81015-43	500
18mm Euro Screw (11/16")	83000-43	500
7.5mm Euro Screw (5/16")	83001-43	500
2 Euro Screw 11mm (7/16") Pozi	499.360.61.1015	500
Euro Screw 13mm (1/2") Pozi	499.360.61.3015	500

### Wood Screw, Nickel-plated



Description	Item No.	PU
#6 x 1/2" FHP, NI	81014-43	500
#6 x 7/16" FHP, NI	81016-43	500
#6 x 5/8" FHP, NI	81001-43	500
#6 x 3/4" FHP, NI	81003-43	500
#6 x 1" FHP, NI	81004-43	500

### Wood Screw, Nickel-plated

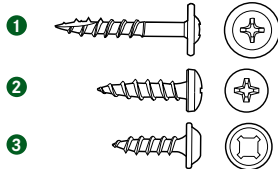

Description	Item No.	PU
1 #8 x 1 1/8" Truss Head	81012-43	500
2 #10 x 3/4" PHP	81007-43	500
3 #8 x 5/8" Quad Round	81017-43	500

### Dowels, Plastic



Description		Item No.	PU
Dowel, TEC Hinge	8mm	00102-43	500
Spax screw for TEC Hinge Dowel		02445-43	500
Dowel, Nexis	8mm	522.000.31.9750	500
Dowel, Tiomos	8mm	<b>F072135773</b> 247	1000
Dowel, VZ Hinge Cup	8mm	04885-43	500
Dowel, Zargen / ZBox	10mm	05853-42	100
Dowel and screw set Zargen	10mm	12768-37	1
Dowel, base plate	10mm	05404-43	500
Dowel, pilaster dowel	8mm x 16mm	00395-43	500

### Pozidrive Screwdriver

- #2 Pozidrive screwdriver for hinges



Description	Item No.	PU
Pozidrive screwdriver	98000-01	1
Pozidrive screwdriver	98000-08	50

PU - Packaging unit

# Machinery

## GRASS PRO1 and ZRam for ZBox and Zargen assembly

### GRASS PRO1

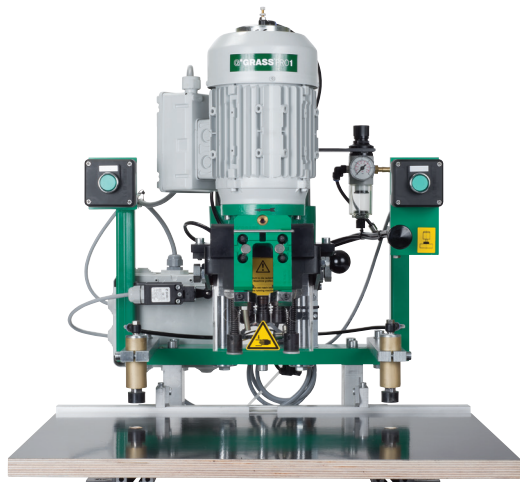

- Depth stop can be adjusted to material thickness
- Functional design
- Easy, fast and efficient operation
- Easy maintenance
- 3 spindle gear box

Description	Item No.	PU
220v single phase pneumatic	80131	1
220v three phase pneumatic	80132	1

Description	Item No.	PU
10 mm Carbide, LH Drill Bit	00222-01	1
Router Bit	00197-01	1

### ZBox Conversion Kit

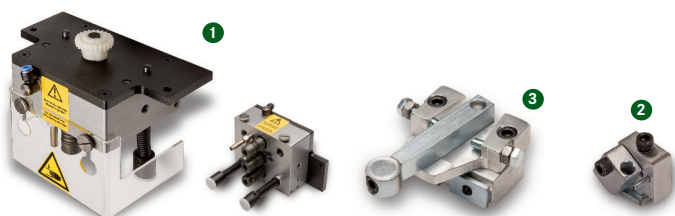

Description	Item No.	PU
1 Pro1 Gear Box	80151	1
2 Pro1 13mm Fence Stop	80152	1
3 Pro1 Side-to-side Stop	80153	1
Pro1 Kit (Gear box, fence and side stops)	80154	1

### ZBox Router Bit

This bit is designed for grooving and beveling the drawer bottoms for the lipped version of the ZBox drawer slide. The bit comes only with a 1/2" shank.

Description	Item No.	PU
6036 Router Bit	00197-01	1

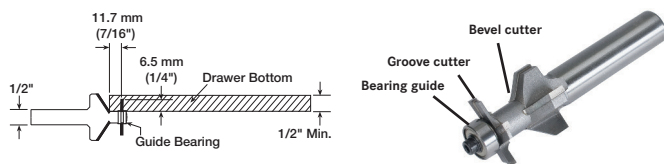

### ZRam

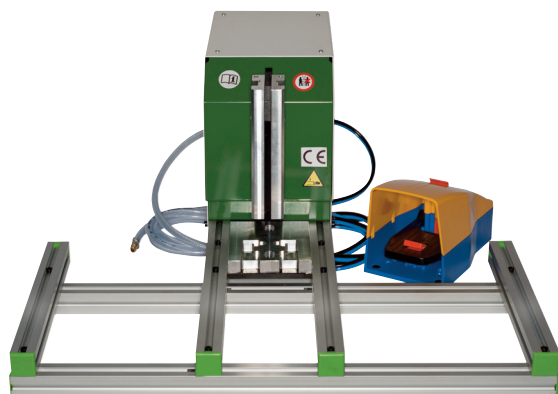

- Designed for manual assembly of dowelled ZBox 6023, 6223, and 6423
- Operated by a foot pedal - air required
- No adjustment required when using various drawer heights
- Economical solution for drawer assembly

Description	Item No.	PU
ZRam	93250-01	1

PU - Packaging unit

## GRASS PRO1 drilling and insertion machine for 45mm boring pattern

### GRASS PRO1



- Depth stop can be adjusted to material thickness
- Functional design
- Easy, fast and efficient operation
- Easy maintenance
- 45mm boring pattern

Description	Item No.	PU
220v single phase pneumatic	94559-01	1
220v three phase pneumatic	94560-01	1
110v single phase pneumatic	94561-01	1

### GRASS PRO1 Features

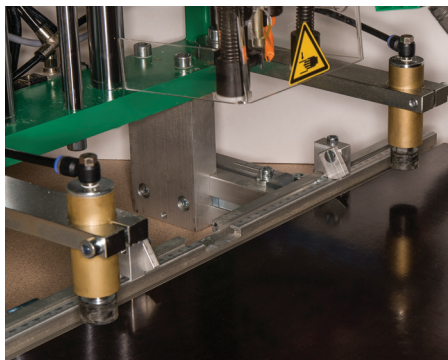

#### Adjustable hold-down devices

Adjustable hold-down devices are suitable for a wide range of material thicknesses. Holds door firmly in place for drilling and insertion and features manual release.

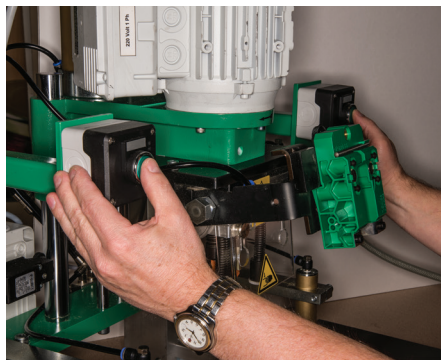

#### Pneumatic controls

Two-hand start button controls for safe drilling and insertion functions.

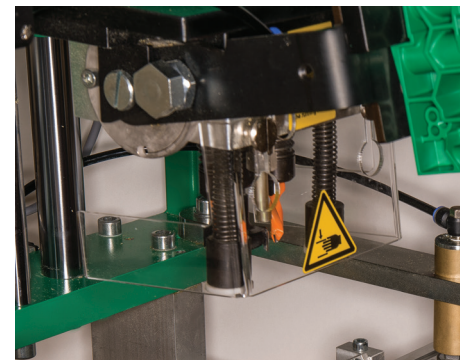

#### Quick change chucks

Easy drill bit removal and insertion using quick change chucks.

PU - Packaging unit

# Machinery

## GRASS PRO1 accessories

### Drill Bits

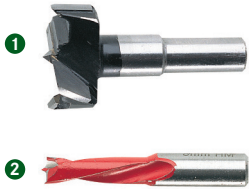

Description	Item No.	PU
1 35mm diameter, RH	00077-01	1
2 8mm diameter, LH	00160-01	1

Description	Item No.	PU
American Bit set for hinge drilling 1 x 35mm/RH, 2 x 8mm/LH	00213-01	1

### Fence Stops

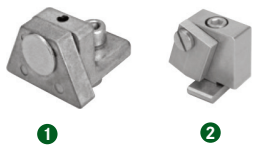

Description	Item No.	PU
1 Additional fence stop	949.200.21.0000	1
2 Universal fence stop	949.200.21.0100	1

### Insertion Dies



Description	Item No.	PU
1 Tiomos 110°/120°	<b>F146101310201</b>	1
2 Universal Die for Tiomos 110°/120°/100°	<b>F146101308201</b>	1
3 TEC Die for all cup styles	92617	1
4 Nexis 110° / 125°	04216-01	1
5 Nexis 170°	04218-01	1

### Extension Fence



Description	Item No.	PU
Extension fence 400mm to 1650mm	88612-01	1

PU - Packaging unit

### GRASS GPS

**TIOMOS CALCULATOR for iPhone NEW!**  
Download on the App Store

**GPS**  
Your personal guide to accurate product navigation.

**GRASS PRODUCTSELECTOR**

Find your way quickly and easily through the product specification process. The GRASS GPS System makes it so easy to order products that will fit your applications and get the perfect part for your project. get installation help and have Grass product specs at your fingertips, on your desktop, ready when you are. Download new modules as they are developed. Click here for more information:

[DOWNLOAD NOW >>](#)

**DYNAPRO**  
Drawer Slide Specification Manager

**TIOMOS**  
Hinge Specification Manager

**KINVARO**  
Door Lifter System

**KINVARO**  
DOOR LIFTER SYSTEM

**Door Lifter Calculator**

Please choose one of the lifters below to see more information and calculate your door weight.

- PARALLEL LIFTERS  
CALCULATE
- BIFOLD LIFTERS  
CALCULATE
- FLAP LIFTERS  
CALCULATE

[CATALOG](#) | [LIFTER TYPES](#) | [EXIT](#)

**TIOMOS**  
HINGE SYSTEM

**Tiomos Hinge Calculator**

Please click the icon below to see more information and calculate your hinge and hardware.

[CALCULATE](#)

[CATALOG](#) | [HINGE TYPES](#) | [EXIT](#) | [GPS](#)

**DYNAPRO**  
DRAWER SLIDE SYSTEM

**Dynapro Slide Calculator**

Please click the icon below to see more information and calculate your length and hardware.

[CALCULATE](#)

[CATALOG](#) | [SLIDE TYPES](#) | [EXIT](#) | [GPS](#)

Kinvaro Door Lifter System offers a new dimension in accessibility. Make sure your projects are properly fitted with the best mechanism. Our Kinvaro Calculator helps you determine which should be used with your door size.

Tiomos Hinge System is easy to configure. Enter all the options you need from Tiomos and get a solution right away. Our Tiomos Calculator helps you determine which hinge should be used with your door size.

Dynapro Drawer Slide System is now available on the Grass GPS! Enter all the options you need and get instant product numbers for ordering. Our Dynapro Calculator helps you determine which slide should be used with your drawer size. Download the Grass GPS today!

Visit our website at [www.grassusa.com](http://www.grassusa.com) to get the Grass GPS.



GRASS America Inc.  
1202 NC Highway 66 South  
Kernersville, NC 27284

Phone: 1-800-334-3512  
Fax: 1-800-525-8406

**Website:** [www.grassusa.com](http://www.grassusa.com)  
**E-mail:** [info@grassusa.com](mailto:info@grassusa.com)

GRASS Canada Inc.  
10 Newgale Gate, Unit 7  
Toronto, ON M1X 1C5

Phone: 1-800-461-4975  
Fax: 1-416-335-5907

**Internet:** [www.grasscanada.com](http://www.grasscanada.com)  
**E-Mail:** [info@grasscanada.com](mailto:info@grasscanada.com)



[www.grassusa.com](http://www.grassusa.com)